

**PRODUCT RANGE UNITS: WATER-LIQUID PUMPS
SUBMERSIBLE – TRANSFER - HYDROPONIC**

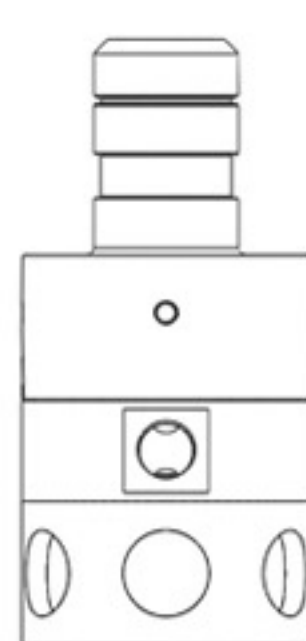

Size 25 – 25, 32, 50, 63 OD

Size 25 – 1", 1-1/4", 2"

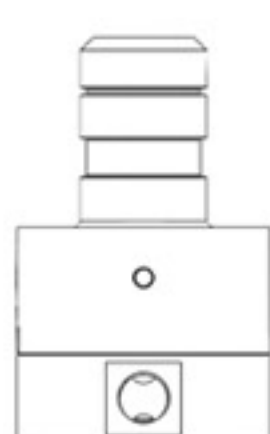
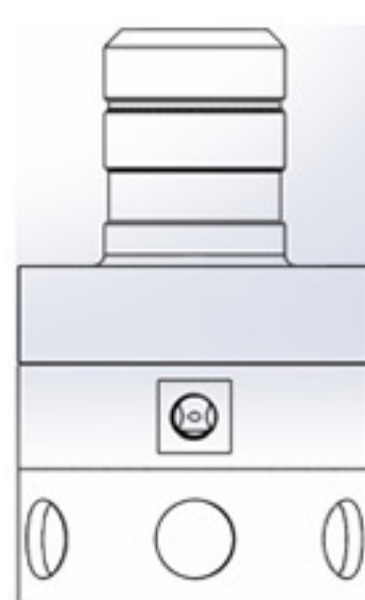

Size 50 – 50, 63, 80 OD

Size 50 – 2", 3"

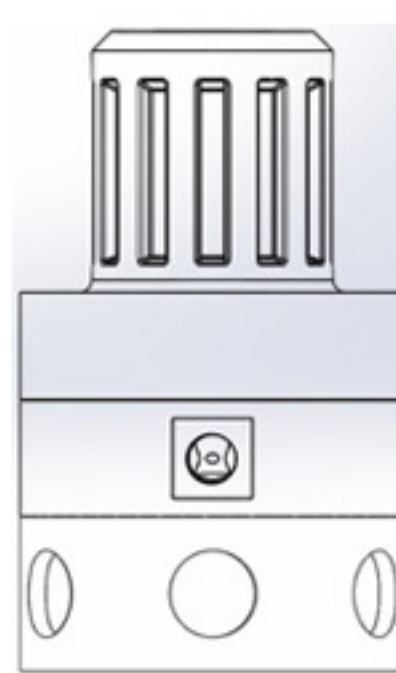
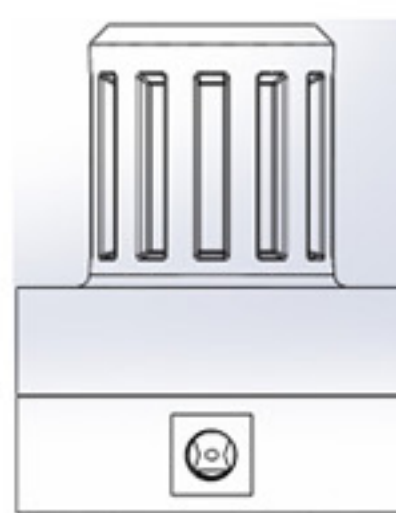
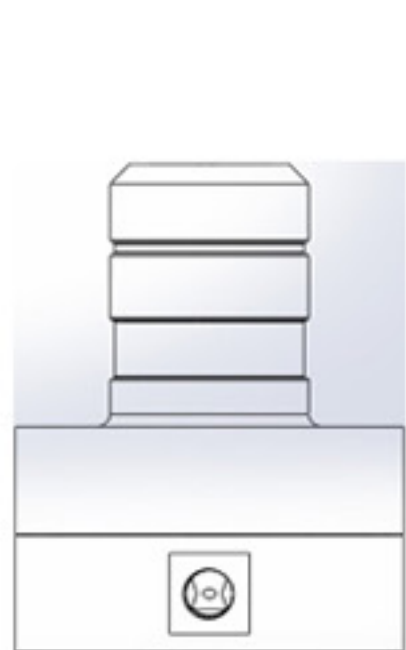

Size 50 – 4"

Size 50 – 5"

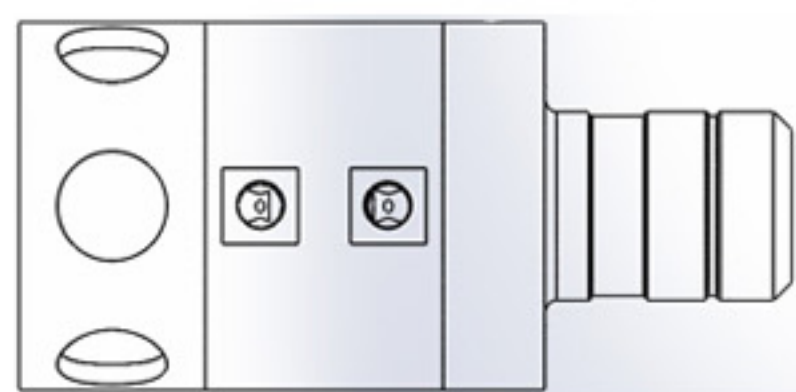
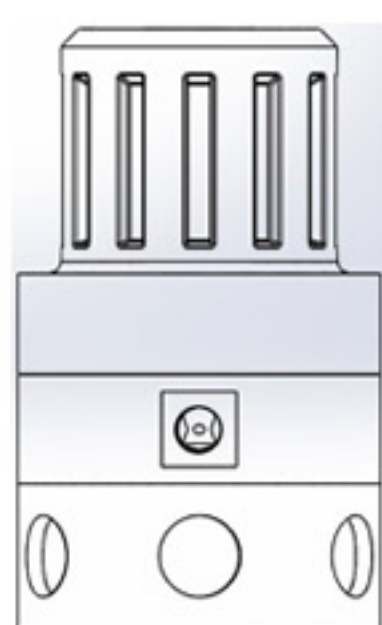
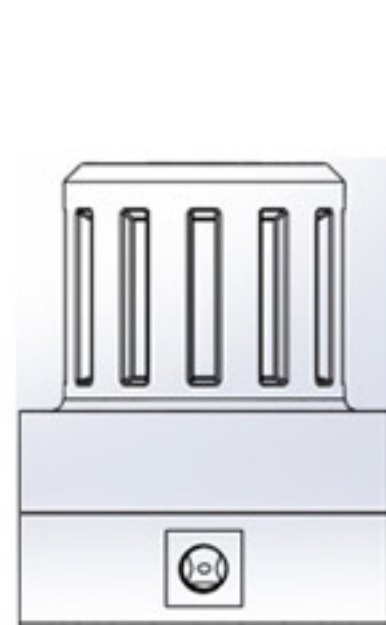

Size 50 – 6"

Size 50 – Specials

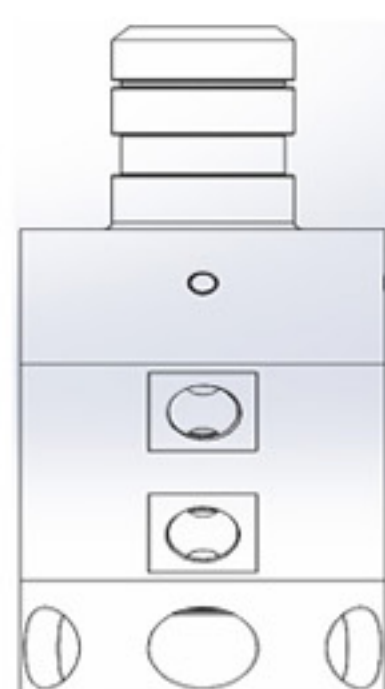

Size 25 – Special

Size 50 – Special

*****With SEDIMENT DISPERSER-FLUIDISER Attachment*****

BOREHOLE – TRANSFER

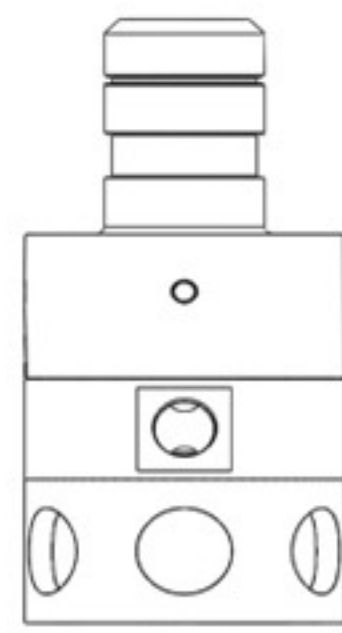
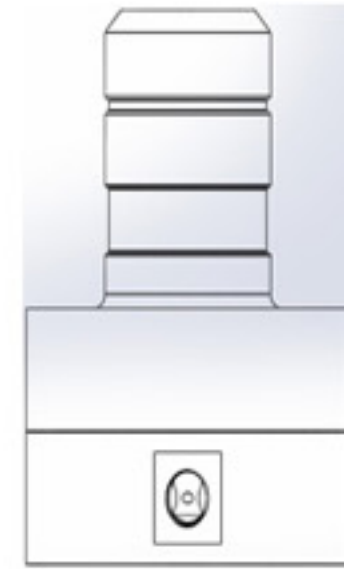
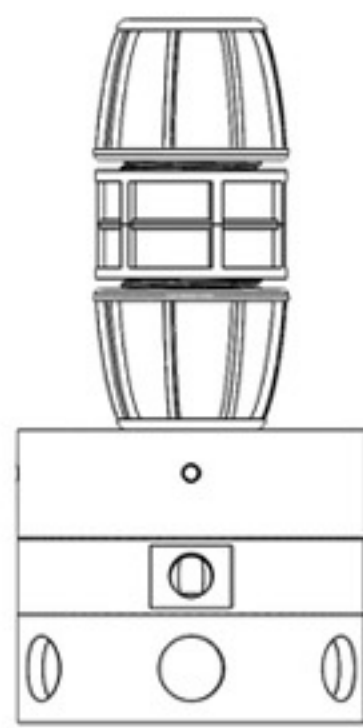
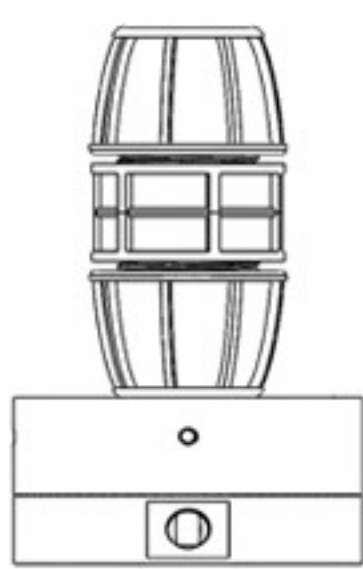

**Size 25 – 5" Bore 25, 32 OD
Size 25 – 5" Bore 50, 63 OD**

**Size 25 – 5" Bore 1-1/4" Hose
Size 25 – 5" Bore 2" Hose**

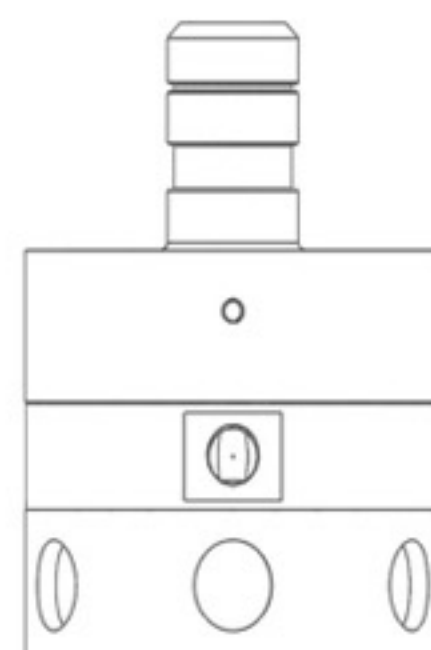
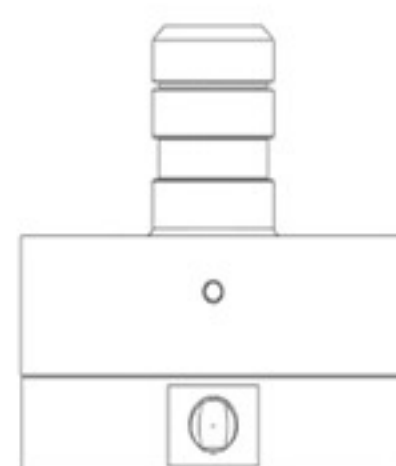
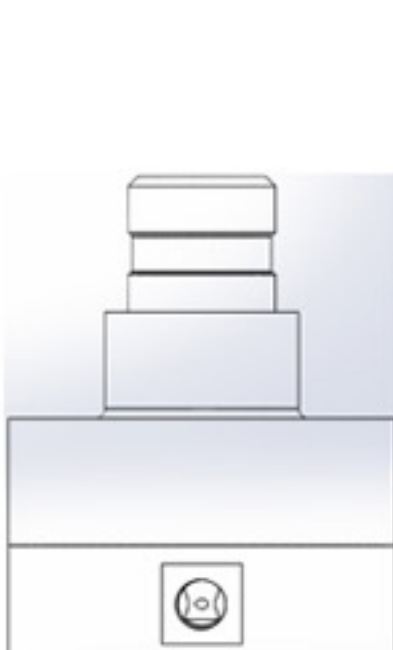

**Size 50 – 8" Bore – 3" Hose
Plus: 2" Hose & 80 OD Tube options**

Size 50 – 8" Bore – 4" Hose